

FEATURES:-

- 6 digit LCD resettable or non-reset totaliser (12mm high), 5 digit flowrate
- **Total in Litres or optional KiloLitres**
- **Flowrate in LPM or optional LPS**
- Easy reset of total via flip top lid.
- $\pm 2.5\%$ accuracy, at 0.7 - 8.0 m/s flow velocity
- Repeatability: $\pm 1.0\%$
- Internal 3.6 v Lithium Battery (8+ year life).
- Max. Process Temperature 110 °C
- Max. Ambient Temperature 55 °C
- Max. Operating Pressure: PVC Tee' options rated to 1100 kPa
All Metal Tee options are rated 2000 kPa
- With simple installation pipe fittings/adapters.
- For pipe sizes from 20 to 100 mm (short stem version) or 125 to 500mm (long stem version)
- Optional pulse output, via M12 IP67 plugset



- Robust ABS-UV IP65 Display housing
- NEW: Dual Hinged robust lid protects LCD from sunlight, with magnet secure function.
- NEW: Slip insertion sensor design with locking cap allows simple removal from pipeline if cleaning rotor.
- NEW: Easier Access for re-calibration and user friendly smart 1 point re-calibration function –self calculation for a new K- factor.
- NEW: Optional External re-calibrate via Portable Device with RFID and EWM calibration software.
- NEW: Dual display: Rate + Reset Total 6-digit LCD (12mm high) counts in LITRES or KILOLITRES.
- NEW: Pulse Output is Live even when lid is closed or **optionally** Pulse Output is Disabled when lid is closed (code **-PNL**)
- NEW: Option for continuous Live LCD (code **-NS**)



**'Dual Display'
6 Digit Resettable
Running Total &
5 Digit Flow Rate**



**MRTU6-GAL50
with 50mm (2")
GAL Pipe Fitting**

MRTU6: Ideal in Irrigation and many other general water measurement and monitoring applications. Incorporating the widely used RPFS sensor design.



**MRTU6 with PVC
Pipe Adaptor Fitting**



**MRTU6 with
Saddle Clamp Fitting**

The *MRTU6* resettable counter flowmeter is designed and manufactured in Australia by ManuFlo. The *MRTU6* has a unique 'quick release' slip insertion stem section designed to be inserted to the ManuFlo 1" nipple adaptors (part BSPB etc) which allows the display head to be fitted to most 1" BSP female entries. Usually, the *MRTU6* is pre-fitted with a ManuFlo 'T' piece pipe adapter, adapters are available for a range of pipe sizes from 20 to 315 mm diameters, and the adapter range includes Galvanized Iron tees, Class18 Cat19 PVC high pressure tees, and saddle-clamp agricultural poly-pipe fittings, the advantage being we pre-install the *MRTU6* for you on to the fitting and pre-calibrate on our NMI certified test rig (sizes 20mm - 100mm) to obtain the best K-factor value. Or optionally you may purchase our BSPB or BSPB-LS pipe adaptor nipples (1" BSP M external thread) in brass or optional version BSPSS in 316 SS material.

The *MRTU6* is suitable for medium to high flow range liquid flow measurement applications. Being internally battery powered, the unit is ideal in situations where no external power supply is accessible, making them totally portable resettable totaliser and rate flowmeters and with optional pulse output to data logger or PLC. NOTE: As standard the pulse output is live even when lid is closed however this feature can be disabled by adding **-PNL** (pulse is disabled when lid closed) to the order code.

The flowmeter's only moving part (a stainless steel alloy rotor which turns as liquid flows past it) allows registration in Litres (L) or KiloLitres (KL) with up to 3 decimal places on the 6 digit Liquid Crystal resettable display counter with flowrate indicator in Litres per minute (L/M) or Litres per second (L/S) up to 2 decimal places. The main body component, consisting of the electronic counter board, is housed in a robust ABS-UV resistant IP65 enclosure. The LCD display is visible through the toughened ABS-UV window and sealed by a recessed gasket and 4 stainless steel screws. A special scratch resistant film allows optimal reading even in the harshest conditions. The impact resistant ABS-UV lid protects the LCD from prolonged sun exposure, contaminants and breakage.

To operate, open the hinged lid and the previously recorded total will be present, open and close the lid again and the Liquid Crystal Display is zeroed ready for a new batch measurement. Liquid flow turning the rotor blades causes counting on the display. The internal lithium battery has a typical life of 8+ years depending on environmental conditions.

Flowrange and Accuracy	±2.5% (0.6 - 8.0 m/sec velocity) ±1.5% (0.7 - 7.0 m/sec velocity, 10:1 flow curve)
Display readout	<ul style="list-style-type: none"> Flowrate: 5 digit (3x6.5mm) in L/M or L/S up to 2 decimal place Counter: 6 digit (5x12mm) in Litres (L),KiloLitres(KL) up to 3 decimal place
Calibration	<ul style="list-style-type: none"> via 3 internal pushbuttons via PC with RFID reader and EWM Calibration software or (coming soon) ANDROID device with built-in NFC and EWM application
Power Source	3.6v Lithium battery (typically 8+ year battery life)
Display Capsule Rating	IP65
Max. Operating Temperature	55 °C (standard 'Short Stem' body version) or 120 °C with 'Long Stem' version
Max. Pressure Plastic Pipes	1100 kPa for PVC Tee's, PVC & Poly saddle clamps
Max. Pressure Metal Pipes	2000 kPa for Galvanised Iron, Stainless steel and Gunmetal Tee pieces
Pulse Output (optional)	<ul style="list-style-type: none"> via optional IP67 M12 plug set (5m lead). N-Channel MOSFET, 5-100VDC 1 Amps Max scalable from 1 to 1000 Litres per pulse, 100 Hz maximum, 5 ms pulse width
External Reset Input (optional)	Passive input via 2 wire volt free contact for PLC or external totaliser reset switch.
Weight (head only, unpacked)	0.4 kg

MATERIALS:	SHORT STEM BODY	LONG STEM BODY
MRT Housing	ABS-UV & 316 SST Screws	
Viewing Window	ABS-UV (c/w 3M 'anti scratch' protection film)	
Housing Gasket	Neoprene	
Body / Bushes	Delron / Delron	Bronze / Delron
O-Rings	Nitrile	
Rotor	Stainless Steel 17-4PH	
Axle	Tungsten Carbide	
Lock Cap	Polypropylene	
Nipple Adaptor	Brass or 316 SST	Brass
Pipe Fitting Range	Refer Page 6	

PIPE SIZE versus FLOW RANGE GUIDE

Pipe Size	Flowrange (Litres/minute)	
	Min	Max
(mm)	@ ± 2.5%	@ ± 2.5%
20	13	160
25	23	235
32	32	385
40	50	600
50	90	940
63	130	1300
65	140	1400
75	160	1600
80	200	2410
90	265	2670
100	300	3760
110	395	3990
125	515	5150
140	645	6460
150	660	7780
160	845	8820
225	1670	16700
250	2060	20600
280	2580	25860
300	3260	30770
315	3270	32730
500	8700	81900

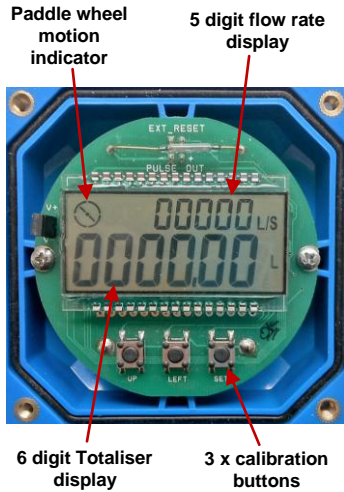

Internal view - PCB

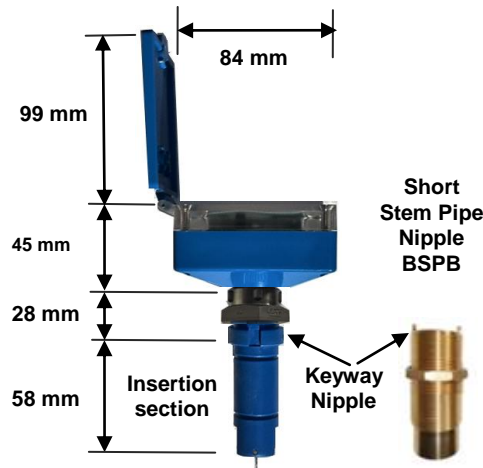

Standard 'Short Stem' body version, pipe ID up to 100mm ID Side view dimensions

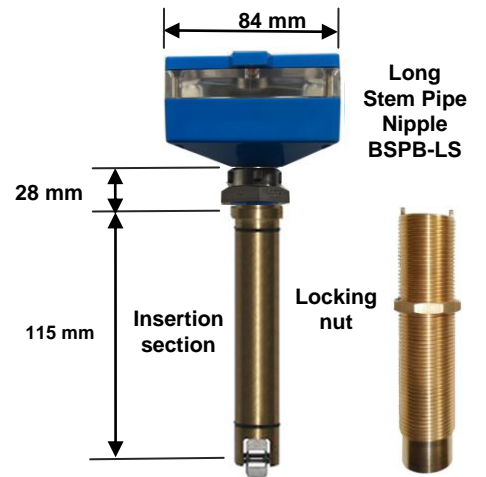

'Long Stem' body version (-LS) for pipe sizes > 100mm ID

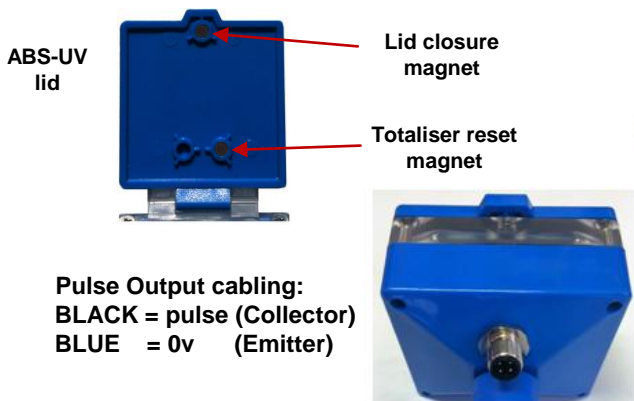

With optional IP67-rated Pulse Output plug set.
 ≤ 100mm : 1 pulse / Litre; > 110mm : 1 pulse / 10 Litres

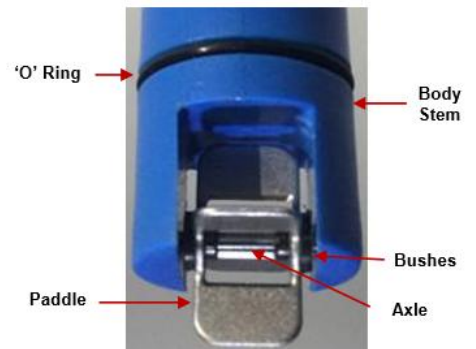

Paddlewheel Sensor

SPARE PARTS	
Code	Description
MRT-TC	Top cover including hinged lid with magnets & SS screws
MRT-CU	Special anti-scratch film from 3M
PW-N	Paddlewheel (rotor) and bushes
PWAH	Axle manufactured from Tungsten Carbide

Adapter Tee keyway fittings are available in:

1. PVC Class 18 Cat. 19 (glue-ends) pressure pipe sizes: 20, 25, 32, 40, 50, 65, 80 & 100 mm.
PVC high pressure saddle clamps: 50, 80, 100, 150, 200 and 300mm.
2. Galvanized Iron threaded connections:
BSP (F): pipe sizes 25, 32, 40 and 50 mm; BSP (M) pipe sizes 80 and 100mm (includes 600mm length of same diameter pipe).
3. Copper/Brass BSP (male) threaded connection end process pipe tube tees 20 mm.
4. Polypipe saddle clamps in pipe sizes 50, 63, 75, 90, 110 mm, up to 315mm. PVC saddles 40, 50, 80, 100, 150, 200 and 300mm.
5. Stainless steel 25mm, others fabricated on request.

**Further custom made fittings are available on request.

Insertion to Pipe (see FIG 1 below):

Ideally the *MRTU6* is purchased factory fitted, and calibrated on our test rig with the chosen pipe adapter fitting (listed above) however should you wish to mount to your own pipe fittings, you must ensure the ManuFlo nipple adaptor option is mounted correctly so that the *MRTU6* rotor is in line with flow direction and the end of the nipple adaptor is protruding approx. one centimeter (10mm) past the Internal Diameter of the pipe so that when the sensor is inserted in to the nipple adaptor it resides at the optimum position to capture flow.

For Tapping into Existing or Larger Pipe Works (see Fig. 1 below):

Use ManuFlo **BSPB**, **BSPB-LS** (Long Stem) Brass or **BSPSS** Stainless Steel pipe adapter keyway nipple - with locknut, which has a 1" OD BSP thread for screwed insertion into 1"(female BSP) half-sockets which can be welded directly to pipe, the BSPB fittings can be coupled to any 1" BSP female entries including saddle clamps.

Installation Conditions:

1. Hydraulic conditions must ensure the *MRTU6* flowmeter has a **full pipe** flow section when measuring (see FIG 2 below).
2. To maintain the stated accuracy curve, lengths of **straight pipe section** (i.e. without any restrictions bends, taps or valves), of the same diameter as the pipe adapter fitting, must be in place for a minimum **10 x pipe diameters** on the incoming (upstream) side, and **5 x diameters** on the exit (downstream) side, of the flowmeter. This will help eliminate flow turbulence to ensure optimum accuracy performance. (see FIG 3).
3. The *MRTU6* can be installed in horizontal, inclined or vertical pipe positions. (Note if mounted in horizontal or inclined pipe, make sure insertion position of sensor is at top or 45° from top, not on the underside).

Exposure to Sunlight:

To prevent LCD fading due to prolonged exposure in direct sunlight **close lid after viewing**.

Display Head Rotation:

After removing holding screws the *MRTU6* top cover and LCD board may be rotated in 90° increments to obtain optimum viewing angle (see FIG 4). Ensure screws are returned and top cover is sealed properly after re-locating head.

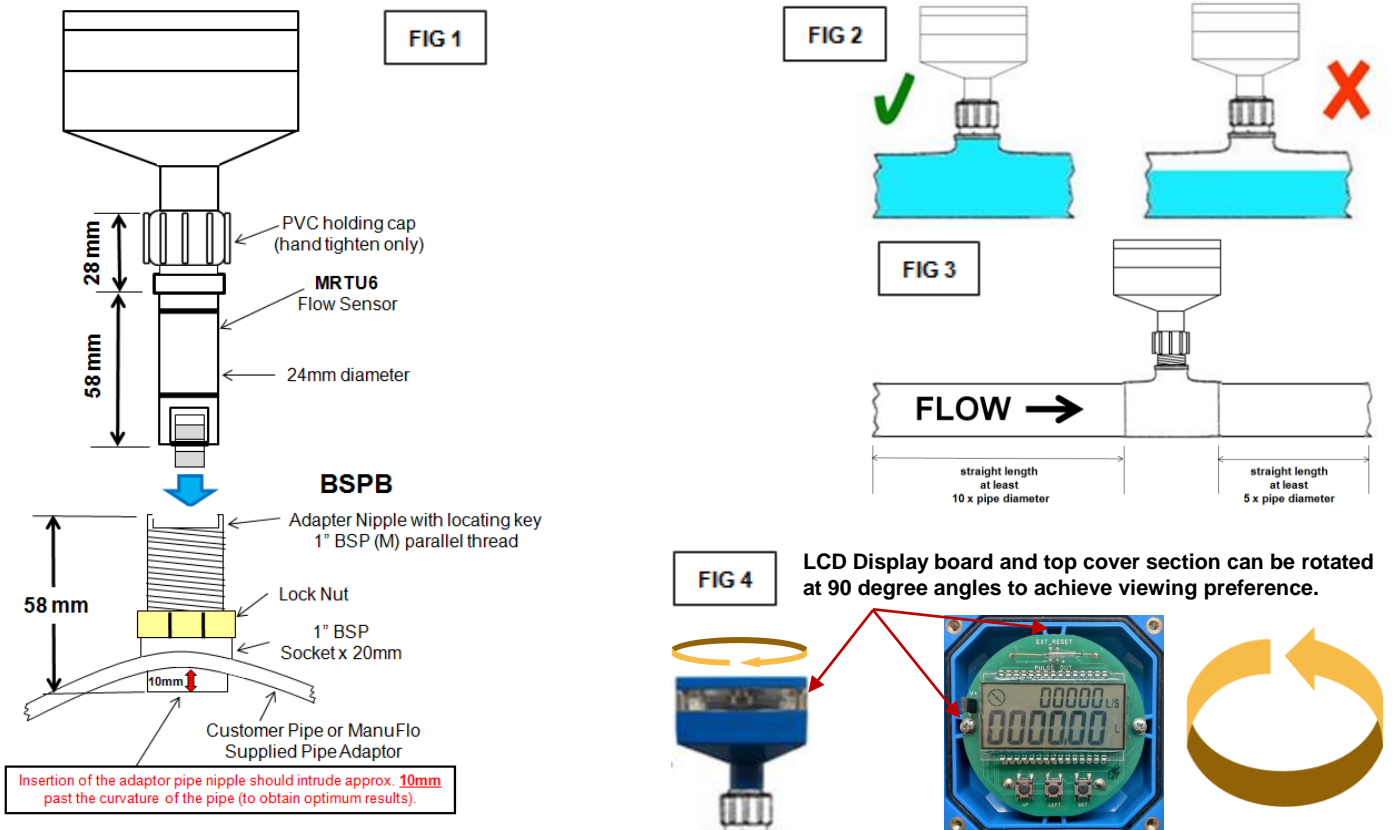

Recommended Periodic Checks:

With clean liquids, sensor check of the paddle wheel is recommended once every year. In applications with reclaimed or contaminated fluids, regular monthly (at least quarterly) maintenance checks are recommended.

Removal of MRTU6 from Pipe adaptor Fitting ‘Square’ Keyway Type Nipple Adaptor:(see FIG 5)

- 1 - Unscrew the black PVC locking cap (anti-clockwise).
- 2 - Hold the neck of the Tee piece in your left hand grasp the enclosure firmly with your right hand and pull upwards (do not twist) until the sensor pops out of the fitting. If the sensor won't release go to step 3.
- 3 - Place a small to medium sized flat thin bladed screwdriver in the join where the sensor meets the nipple adaptor (See FIG 5), twist the screw driver to prize the two apart then pull upwards again until the sensor is released.

Removal of MRTU6 from Pipe adaptor Fitting ‘Triangular’ Keyway Type Nipple Adaptor:(see FIG 6)

- 1 - Unscrew the black PVC locking cap (anti-clockwise).
- 2 - Hold the neck of the Tee piece in your left hand grasp the enclosure with your right hand and turn slowly anti-clockwise until the sensor pops out of slot then pull upwards out of socket.

**When returning the sensor to nipple adaptor insert so the keyway and slots line up then pull down until they locate. Screw the black lock nut clockwise to hold the sensor in place (hand tightened only).

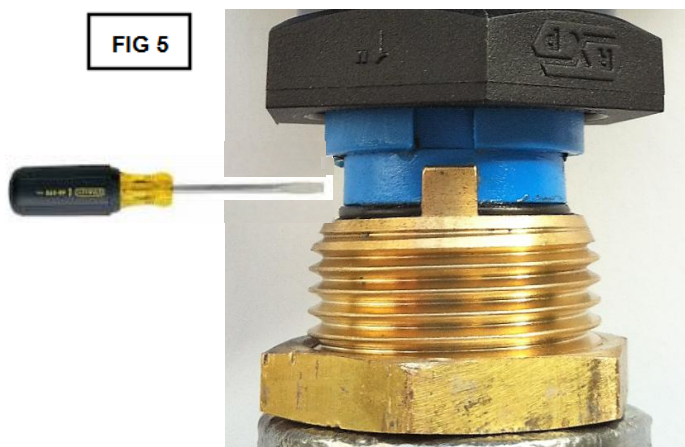

Standard fitting ‘Square’ Keyway

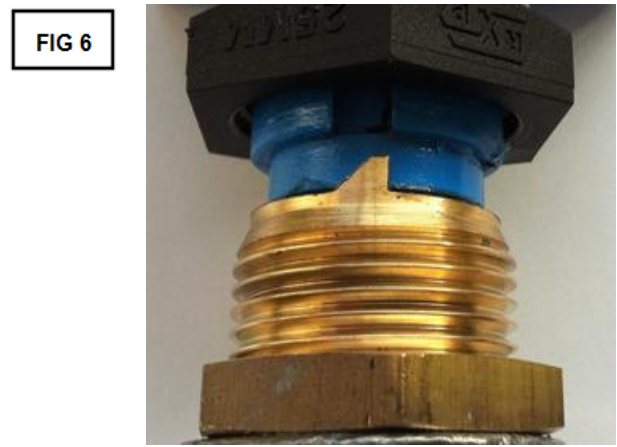

New ‘Triangular’ turn replace fitting

Cleaning:

- 1 - If the paddlewheel (rotor) and or sensor body is coated with scale, immerse the sensor section in diluted hydrochloric acid, scour gently if required.
- 2 - **For ease of removal or refitting of sensor we strongly recommend to lubricate the body O-rings using petroleum jelly.**
- 3 - If the paddlewheel requires servicing, push out the axle using a small hole punch or similar implement, remove the paddle wheel and service or replace rotor and/or axle as required (spare parts available from ManuFlo).

Fault Diagnosis & Rectification:

- If the LCD display is blank, the MRTU6 may be in sleep mode because it is not receiving input pulses from the paddlewheel. The LCD is reawakened once flow restarts, or by closing and re-opening the lid.
- If the flowmeter ceases to count, the paddlewheel may be blocked, remove inspect and clean as described above.
- If the MRTU6 counts when there is no flow, a nearby 50Hz AC field is probably causing false counts. Move the flowmeter away from the 50Hz field, or move the source of the field if practical.
- To access the internal electronic display board to replace the Lithium battery:
 - Refer to “Re-calibration” section for instructions to open the MRTU6 to access the PCB.
 - Two screws secure the PCB - unscrew them and remove the PCB to access the battery on underside.
 - Replace battery with an equivalent unit.
 - Re-insert the PCB,
 - Replace the viewing screen and hand tighten the 4 x SS screws to re-seal the unit.
- When not in use, keep the outer lid should be closed. If prolonged direct exposure to sunlight causes the LCD to fade or discolour, return the MRTU6 to ManuFlo for servicing.

Base Model	Code Position A	B	C	D	E	F	G	H	I	J	K
MRTU6 - (up to 100mm) MRTU6 - LS (>100mm)	Refer to Pipe Adaptor Selection (Page 6)	Pulse -	P Scale -	T Units -	T DP -	F Units -	F DP -	Sleep -	Reset -	ER -	CAL
Pulse Output Options:											
Without pulse output (Default)		0									
With pulse output ('pulse live' lid open or closed)		P									
With pulse output ('pulse not live' when lid closed)		PNL									
Pulse Output Scaling											
1 Pulse / Litre (Default)		1									
1 Pulse / 10 Litres		10									
1 Pulse / 100 Litres		100									
1 Pulse / 1000 Litres		1000									
Totaliser Display Units:											
Litres (Default)		L									
Kilolitres		KL									
Totaliser Decimal Place:											
Without Decimal Place (Default)		0									
With 1 Decimal Place		1									
With 2 Decimal Places		2									
With 3 Decimal Places		3									
Flow Rate Display Units:											
Litres / Minute (Default)		L/M									
Litres / Second		L/S									
Flow rate Display Off		0									
Flow Rate Display Decimal Place:											
Without Decimal Place		0									
With 1 Decimal Place (Default)		1									
With 2 Decimal Places		2									
Sleep Mode (Battery Conservation):											
Sleep in 5 Minutes (Default)- LCD Turns off after 5 mins. without flow - value can be adjusted from 5 to 999.9 mins.		S5									
Sleep Function Off - Display is always live (reduced battery life but still >5 years in most applications)		SO									
Totaliser Reset Options:											
Reset (Default) Totaliser is reset each time the lid is closed		R									
Wake Reset - Wakes the display and retains Total (unless lid closed twice)		WR									
Reset Disabled - Totaliser reset function disabled (running total only)		RD									
External Reset Option:											
No external reset (Default)		0									
External Reset - Totaliser reset via external input (includes IP67 plug and socket c/w 5m cable)		ER									
# Calibration Preference (based on application):											
Standard (Default) - Factory standard calibration orientation: Pipe sizes 20mm & 25mm Vertical, >25mm calibrated in Horizontal plane		S									
Vertical - Flowmeter calibrated in the vertical plane to match customers application		V									
Horizontal - Flowmeter calibrated in the horizontal plane to match customers application		H									

MRTU6 flowmeter sizes 20 - 25mm are factory calibrated in the 'vertical up' position, sizes 32mm> are calibrated in the horizontal plane with a small incline. For these larger sizes there is a small difference (approx. 6%) in the calibration 'K-Factor' from horizontal to vertical calibration, this difference is noticeably greater for flow downward position where gravity plays a part. If the accuracy is critical to your application you should specify your preferred calibration position at order placement.

Example:

Base Model	Pipe Adaptor	B	C	D	E	F	G	H	I	J	K
MRTU6	- GAL25-T2	- P	- 1	- L	- 0	- L/M	- 1	- S5	- WR	- 0	- S









Position Selection Description:

- Code A: **GAL25-T2** 25mm GAL pipe adaptor with straight pipe lengths
- Code B: **P**..... Pulse output
- Code C: **1**..... Pulse output 1 pulse / Litre
- Code D: **L**..... Totaliser in Litres
- Code E: **0**..... Totaliser without decimal point
- Code F: **L/S**..... Flow rate units Litres / Second
- Code G: **1**..... Flow rate with 1 decimal point
- Code H: **S5**..... Display sleep after 5 minutes inactivity
- Code I: **WR**..... Wake reset function
- Code J: **0**..... Without external reset
- Code K: **S**..... Standard factory calibration orientation

Populate for your selection: (If no selection made MRTU6 will be supplied as per 'Default' factory settings highlighted in blue above)

Base Model	Pipe Adaptor	A	B	C	D	E	F	G	H	I	J	K

**** Pipe fitting options for the MRTU6 are as per the following table however other fitting types may also be available on request****

Material	GAL	PVC	PVC	Polypropylene	Polypropylene	STAINLESS	BRASS	BRASS
Type	T-Piece	slip T-piece	Saddle Clamp	SaddleClamp	SaddleClamp	T-Piece	T-piece	Socket
For	Gal pipe	Pressure pipe	Pressure pipe	PVC Irrigation pipe	Poly Pipe Black	S/Steel pipe	Brass pipe	
20 mm		PVC20					BRA20	
25 mm	GAL25 (-T2)	PVC25				SS25	BRA25	
32 mm	GAL32	PVC32						
40 mm	GAL40	PVC40	PVC40SC	SCP40	SC40			BSOC: 1" BSP Brass pipe socket adaptor for 32-500mm pipes also BSPB & BSPSS nipple adaptor
50 mm	GAL50	PVC50	PVC50SC	SCP50	SC50			
63 mm					SC63			
65 mm		PVC65		SCP65				
75 mm					SC75			
80 mm	GAL80	PVC80	PVC80SC	SCP80	SC80			
80 mm	GAL80-F (Table D flanged)							
90 mm					SC90			
100 mm	GAL100	PVC100	PVC100SC	SCP100				
100 mm	GAL100-F (Table D flanged)							
110 mm					SC110-LS			BSOC: 1" BSP Brass pipe socket adaptor for 32-500 mm pipes also BSPB-LS Long Stem nipple adaptor
125 mm				SCP125-LS	SC120-LS			
140 mm					SC140-LS			
150 mm			PVC150SC-LS	SCP150-LS				
160 mm					SC160-LS			
200 mm			PVC200SC-LS	SCP200-LS	SC200-LS			
225 mm				SCP225-LS	SC225-LS			
250 mm				SCP250-LS	SC250-LS			
280 mm					SC280-LS			
300 mm			PVC300SC-LS	SCP300-LS				
315 mm					SC315-LS			
500 mm								
								
	Galvanised Iron, threaded ends BSP(female). 2000 kPa NOTE: 25mm can be supplied with straight pipe sections already fitted (Part GAL25-T2)	PVC T-piece Class 18, Cat 19 Glue-in (female) 1100 kPa	PVC 1400 kPa	PVC ≤ 150mm: 1600 kPa > 150mm: 1000 kPa	Poly-pipe agricultural Saddle Clamps. ≤ 150mm: 1600 kPa > 150mm: 1000 kPa	Stainless Steel 316 T-piece. BSP (female) threaded entry 2000 kPa	Brass T-piece BSP (female) threaded entry 2000 kPa	1" BSP Brass pipe socket adaptor & BSPB BSPB-LS BSPSS nipple adaptors (see Fig 1 Page 3)



GAL80 - 80mm Galvanized Iron pipe adapter (80mm φ x 600mm long)

IMPORTANT:
 The display head is factory programmed according to the pipe size, and the display head and its pipe adapter are calibrated together to operate as one unit.
 DO NOT remove the flowmeter and place it on a different sized pipe adapter, because the display will require re-calibration before it can measure properly on the new pipe size.

Calibration is via the three internal pushbuttons (marked **UP**, **LEFT** and **SET**) located underneath screen.

- Note: The calibration (K-factor) characteristics can vary up to 6% between horizontal or vertical runs.
- Run liquid through the MRTU6 into a calibrated vessel or load cell, until at least 50 Litres is displayed on the MRTU6. For accuracy, keep flowrate continuous and above minimum flowrange for the pipesize.
- Compare the actual amount collected against what is displayed on the MRTU6. If the amount collected matches the amount displayed within $\pm 2\%$, then no adjustment to calibration is necessary.
- **Formula:** $Percentage\ error = (Amount\ displayed - Amount\ collected) / Amount\ displayed \times 100$
- If the percentage error is more than $\pm 2\%$, please follow **1 point calibration** procedure.
- **To access buttons**, open the hinged lid and remove the four SST screws holding the viewing window to the enclosure. Set the viewing window aside in a safe place you will now be able to see the green electronics board.

Adjusting the Calibration Value using the internal Calibration push buttons SET, LEFT and UP.

Internal Push Buttons **UP**, **LEFT** and **SET**

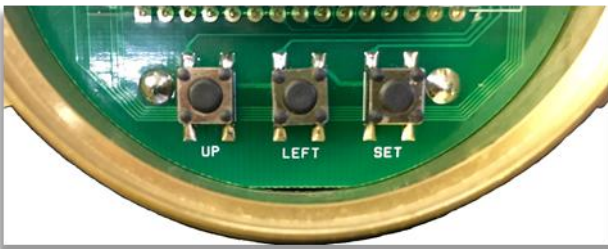

1 Point Calibration Function: (User friendly, No calculations needed)

Step 1. Press **UP** button for approximately 5 seconds

LCD display in 1 point calibration mode.



Step 2. Start flow (Run liquid through the MRTU6)

- Calibration will automatically start upon flow detection.
- Display must have at least 100 counts or more to have an accurate calibration before stopping the flow.

Example: Display = 119 C (counts)



Step 3. Stop flow

- After flow is completely stopped, wait for approximately 10 seconds and the display will update to allow entry of collected amount of liquid in litres.

LCD display, 10 seconds after flow stops.



Step 4. Enter volume collected in Litres.

Example: Volume = 20.15 Litres



- Press **LEFT** button to select desired digit to be change.
- Press **UP** button to change the value of selected digit.
- Press **SET** to lock in the changed value.

Step 5. Press **SET** to display Gear Rate.

Example: Gear Rate: 4.9 Counts/Litre



Note:

Gear Rate value will be shown for approximately 5 seconds then display will revert to counting mode (main display), this is the indication that the meter has been successfully re-calibrated.

Example: Main display in L/M and Litres (L)



Step 6. Verify that the meter has been properly re-calibrated.

- Do one or more test run and verify if the MRTU6 displayed amount is now within $\pm 2\%$ error.
- If satisfied, properly mount the glass window and locking ring back to its original state.
- Otherwise, repeat Steps 1 to 6

Note: MRP5 re-calibration procedure is still applicable to MRTU6 meters. If MRP5 re-calibration procedure is preferred, please refer MRP5 User's Manual.

